



## S6

### Multivoltage 50x50 mm compact sensors series

- 50x50 mm compact dimensions
- Free voltage Vac/Vdc models with relay output
- 10-30 Vdc model with transistor output
- Standard cable or M12 4-pole connection



SENSORS

#### APPLICATIONS

- Automatic machines
- Packaging lines
- Transportation lines
- Automatic warehouses



S6		
Through beam		0...20 m
Retroreflective (on R2 reflector)		0,1...6 m
Polarized retroreflective (on R2 reflector)		0,1...5 m
Diffuse proximity		10...900 mm
		10...2000 mm
		30...100 mm
Background suppression		30...250 mm
		100...500 mm
Power supply	Vdc	10...30 V
	Vac	
	Vac/dc	15...264 Vac/Vdc
Output	PNP	▪
	NPN	▪
	NPN/PNP	▪
	relay	▪
	other	
Connection	cable	▪
	connector	▪
	pig-tail	
Approximate dimensions (mm)		18x50x50
Housing material		ABS
Mechanical protection		IP65

TECHNICAL DATA	
Power supply	10 ... 30 Vdc limit values (mod. S6/S6T/S6R-5) 15 ... 264 Vac/Vdc (48 ... 60 Hz) limit values (mod. S6-1)
Ripple	2 Vpp max.
Consumption (output current excluded)	30 mA max. (mod. S6/S6T/S6R-5) 40 mA max. (mod. S6-1)
Light emission	IR LED 880 nm red LED 660 nm (mod. S6/S6R/S6T...B/M10)
Setting	sensitivity trimmer (excl. mod. S6...G, S6R-5-M) adjustment screw (mod. S6/S6T/S6R-5-M)
Operating mode	LIGHT/DARK selection by cable or connector (mod. S6/S6T/S6R-5) LIGHT/DARK selection by N.O./N.C. output (mod. S6R-5-M) LIGHT/DARK selection by trimmer (mod. S6-1)
Indicators	red OUTPUT LED (excl. mod. S6...G), POWER LED (mod. S6...G) green STABILITY LED (mod. S6-5-M25)
Output	NPN/PNP (mod. S6) PNP (mod. S6T) NPN or PNP; NC; NO (mod. S6R) Relay 1 NO and NC contact 250 Vac, 30 Vdc min. applicable load 5 Vdc, 10 mA (mod. S6-1)
Output current	100 mA max., 3 A max. (mod. S6-1)
Saturation voltage	1,5 V max. (NPN/PNP output)
Response time	1 ms max. 2 ms max. (mod. S6/S6R/S6T...F/G) 30 ms max. (mod. S6-1)
Switching frequency	500 Hz 250 Hz max. (mod. S6/S6R/S6T...F/G) 16 Hz (mod. S6-1)
Connection	2 m cable Ø 6 mm (mod. S6-1), 2 m cable Ø 5 mm (mod. S6-5), M12 4-pole connector (mod. S6T-S6R)
Dielectric strength	500 Vac, 1 min between electronics and housing
Insulating resistance	>20 MΩ, 500 Vdc between electronics and housing
Electrical protection	class 2, class 1 (mod. S6-1)
Mechanical protection	IP65
Ambient light rejection	according to EN 60947-5-2
Vibrations	0,5 mm amplitude, 10 ... 55 Hz frequency, for every axis (EN60068-2-6)
Shock resistance	11 ms (30 G) 6 shock for every axis (EN60068-2-27)
Housing material	ABS UL 94V-0
Lens material	PMMA plastic
Operating temperature	-25 ... 55 °C
Storage temperature	-25 ... 70 °C
Weight	160 g max. cable vers., 40 g max. conn. vers.

## DIMENSIONS

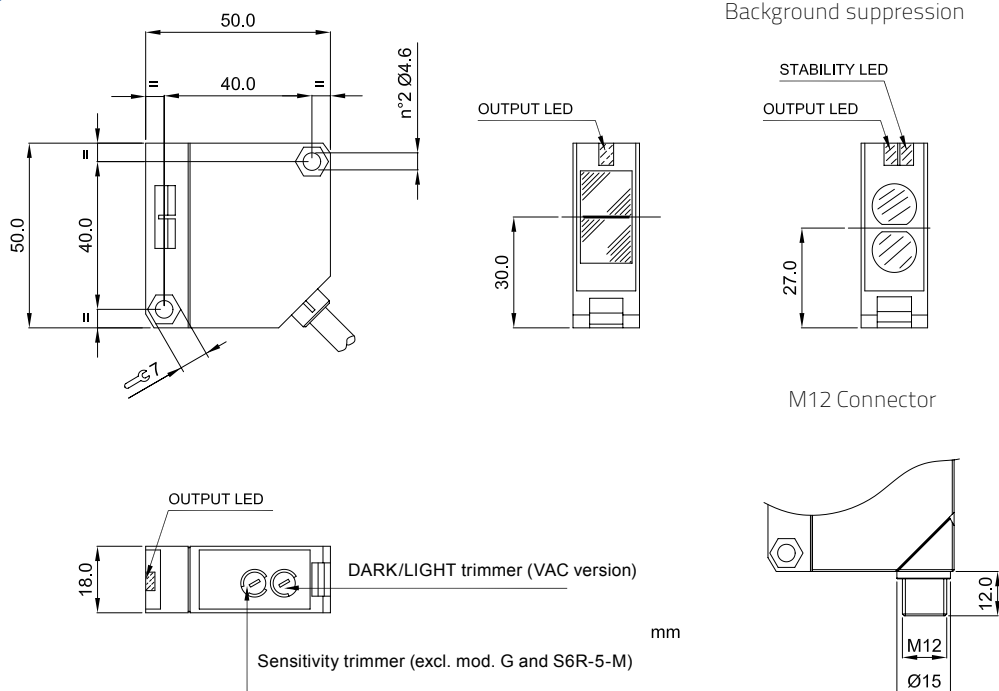

## CONNECTIONS

### VDC MODELS

NPN/PNP version

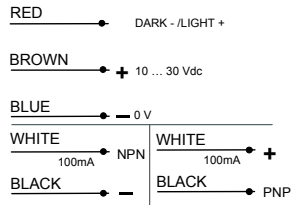

Through beam receiver - NPN/PNP version

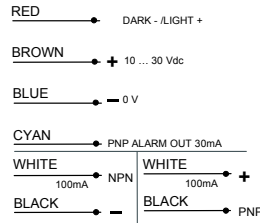

Through beam emitter - NPN/PNP version

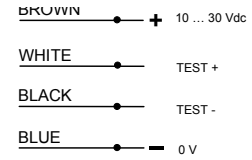

NPN or PNP and NC/NO version

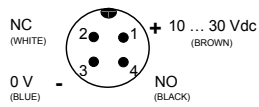

PNP version

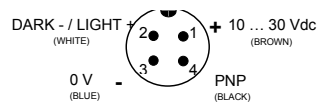

Through beam emitter - PNP version

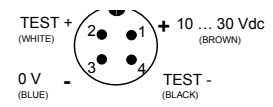

### VAC MODELS

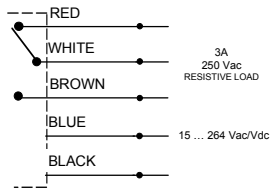

Through beam emitter

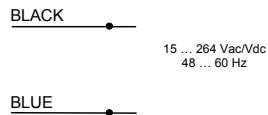

## INDICATORS AND SETTINGS



Background suppression

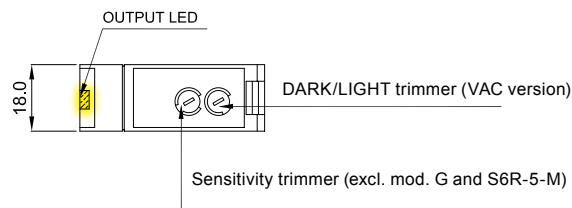
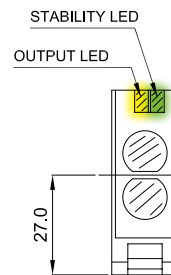
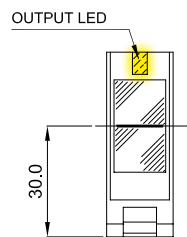

## DETECTION DIAGRAMS

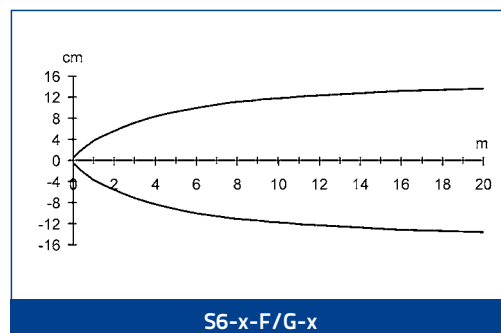
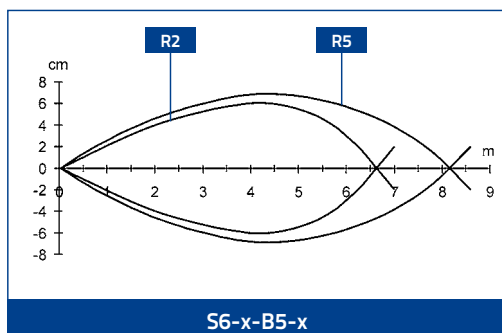
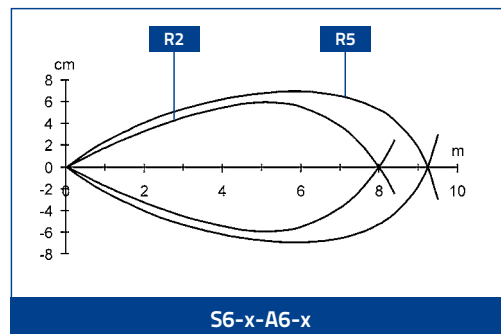
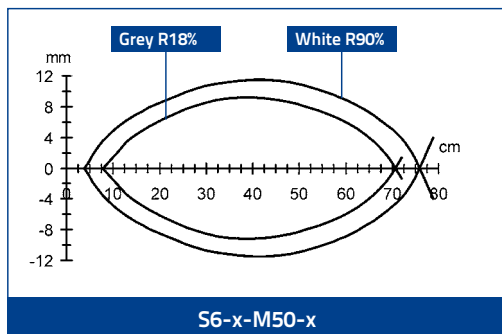
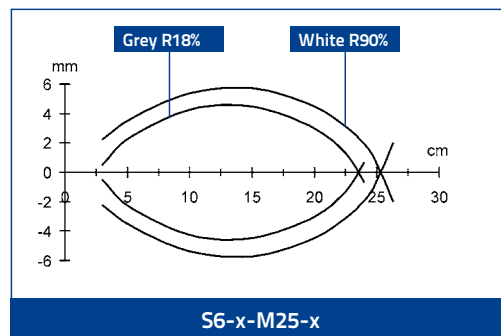
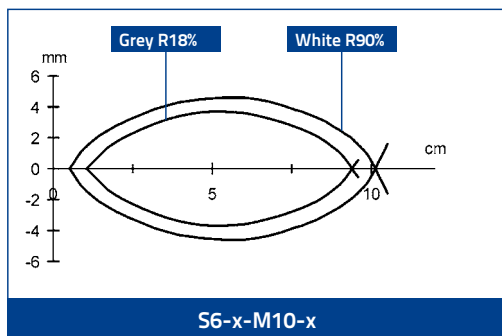
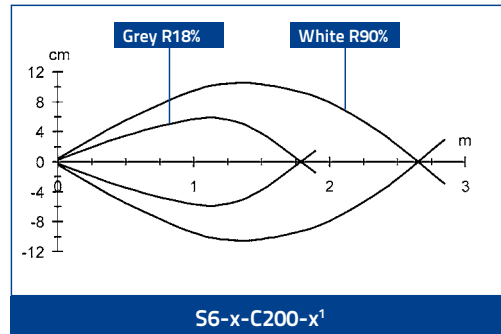
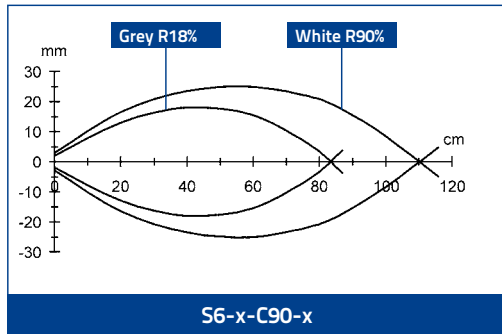

The detection diagrams indicate the typical operating distance with excess gain 1.

## MODEL SELECTION AND ORDER INFORMATION

OPTIC FUNCTION	OPERATING	POWER SUPPLY	OUTPUT	MODEL	ORDER No.
Short diffuse proximity	10...900 mm	15...264 V A.C.	relay SPDT 250V/3A	S6-1-C90	S937530090
			NPN/PNP	S6-5-C90	S937530000
		10...30 V D.C.	PNP N.O./N.C.	S6R-5-C90-P	950201190
			PNP	S6T-5-C90-P	961031020
Long diffuse proximity	10...2000 mm	15...264 V A.C.	relay SPDT 250V/3A	S6-1-C200	950151140
			NPN/PNP	S6-5-C200	950201150
		10...30 V D.C.	PNP N.O./N.C.	S6R-5-C200-P	950201200
			NPN N.O./N.C.	S6R-5-C200-N	956101050
Retroreflective	0,1...6 m (on R2 reflector)	15...264 V A.C.	relay SPDT 250V/3A	S6-1-A6	S937330090
			NPN/PNP	S6-5-A6	S937330000
		10...30 V D.C.	PNP	S6T-5-A6-P	961031000
			PNP N.O./N.C.	S6R-5-A6-P	950201170
Polarized retroreflective	0,1...5 m (on R2 reflector)	15...264 V A.C.	relay SPDT 250V/3A	S6-1-B5	S937420090
			NPN/PNP	S6-5-B5	S937420000
		10...30 V D.C.	PNP N.O./N.C.	S6R-5-B5-P	950201180
			PNP	S6T-5-B5-P	961031010
Background suppression	30...100 mm	10...30 V D.C.	PNP N.O./N.C.	S6R-5-M10-P	950201230
	30...250 mm		NPN/PNP	S6-5-M25	S937830000
			PNP N.O./N.C.	S6R-5-M25-P	950201220
			NPN N.O./N.C.	S6R-5-M25-N	956101080
			PNP	S6T-5-M25-P	961041000
	100...500 mm		PNP N.O./N.C.	S6R-5-M50-P	950201250
Through beam (Receiver)	0...20 m	15...264 V A.C.	relay SPDT 250V/3A	S6-1-F20	S937200090
			NPN/PNP	S6-5-F20	S937200010
		10...30 V D.C.	PNP N.O./N.C.	S6R-5-F20-P	950201160
			PNP	S6T-5-F20-P	961211010
Through beam (Emitter)	-	15...264 V A.C.	-	S6-1-G20	S937130090
		10...30 V D.C.	-	S6-5-G20	S937130000
		-	-	S6T-5-G20	961211000

## ACCESSORIES

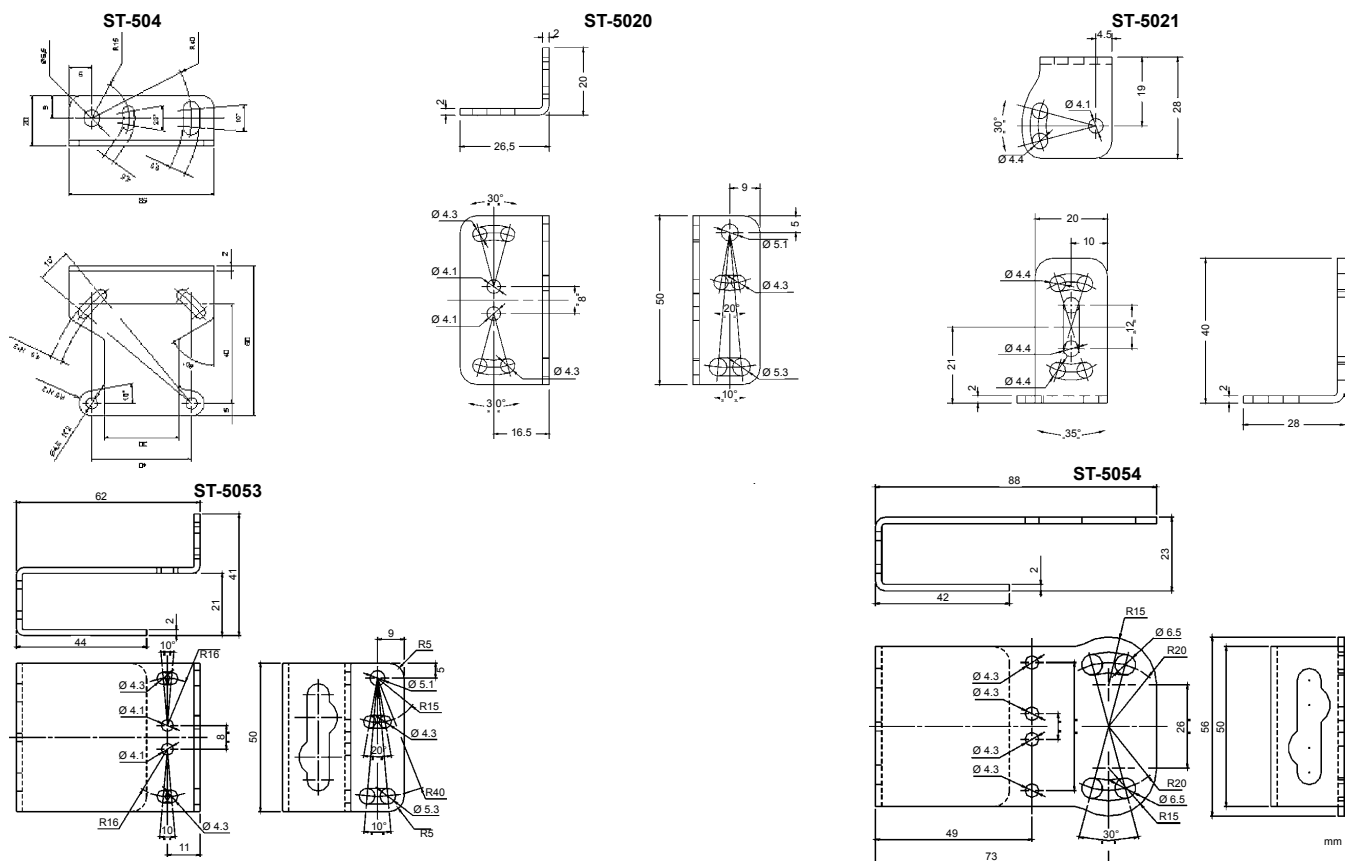

ST-5018

ST-5019

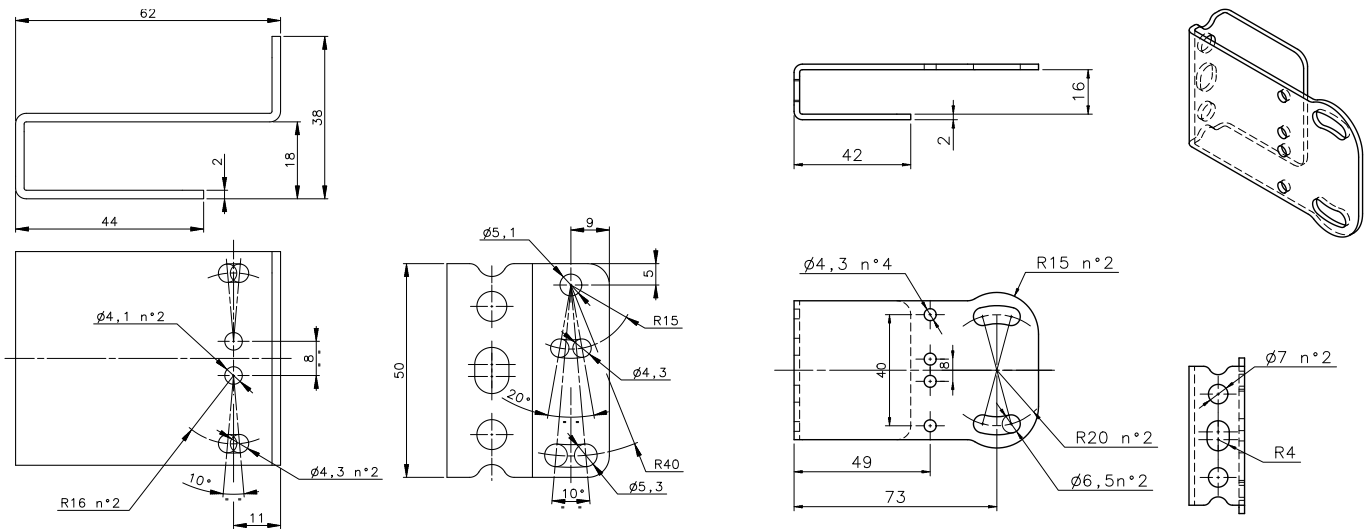

MODEL	DESCRIPTION	ORDER No.
ST-5018	protective bracket	95ACC5310
ST-5019	protective bracket	95ACC5320
ST-5020	mounting bracket	95ACC5330
ST-5021	mounting bracket	95ACC5340
ST-504	mounting bracket	95ACC2820
ST-5053	protective bracket	95ACC2410
ST-5054	protective bracket	95ACC2420
JOINT-S62	protective bracket with jointed support	95ACC2430

## CABLES

TYPE	DESCRIPTION	LENGTH	MODEL	ORDER No.
Axial M12 Connector	4-pole, grey, P.V.C.	3 m	CS-A1-02-G-03	95A251380
		5 m	CS-A1-02-G-05	95A251270
		7 m	CS-A1-02-G-07	95A251280
		10 m	CS-A1-02-G-10	95A251390
	4-pole, P.U.R.	2 m	CS-A1-02-R-02	95A251540
		5 m	CS-A1-02-R-05	95A251560
Radial M12 Connector	4-pole, grey, P.V.C.	3 m	CS-A2-02-G-03	95A251360
		5 m	CS-A2-02-G-05	95A251240
		7 m	CS-A2-02-G-07	95A251245
		10 m	CS-A2-02-G-10	95A251260
	4-pole, P.U.R.	2 m	CS-A2-02-R-02	95A251550
		5 m	CS-A2-02-R-05	95A251570
Radial M12 Connector with LED (for PNP N.O. sensors)	4-pole, grey, P.V.C.	3 m	CS-A2-12-G-03	95A251400
		5 m	CS-A2-12-G-05	95A251350
		10 m	CS-A2-12-G-10	95A251370
Axial M12 Connector	4-pole, shielded, black, P.V.C.	3 m	CV-A1-22-B-03	95ACC1480
		5 m	CV-A1-22-B-05	95ACC1490
		10 m	CV-A1-22-B-10	95ACC1500
		15 m	CV-A1-22-B-15	95ACC2070
		25 m	CV-A1-22-B-25	95ACC2090
Radial M12 Connector	4-pole, shielded, black, P.V.C.	3 m	CV-A2-22-B-03	95ACC1540
		5 m	CV-A2-22-B-05	95ACC1550
		10 m	CV-A2-22-B-10	95ACC1560
Axial M12 Connector	4-pole, U.L., black, P.V.C.	3 m	CS-A1-02-U-03	95ASE1120
		5 m	CS-A1-02-U-05	95ASE1130
		10 m	CS-A1-02-U-10	95ASE1140
		15 m	CS-A1-02-U-15	95ASE1150
		25 m	CS-A1-02-U-25	95ASE1160
Radial M12 Connector	4-pole, black	Connector- not cabled	CS-A1-02-B-NC	G5085002
		Connector- not cabled	CS-A2-02-B-NC	G5085003