

12MBI100VN-120-50

IGBT Modules

IGBT MODULE (V series)

1200V / 100A / IGBT, RB-IGBT 4 in one package

■ Features

- Higher Efficiency
- Optimized A (T-type) -3 level circuit
- Low inductance module structure
- Featuring Reverse Blocking IGBT (RB-IGBT)

■ Applications

- Inverter for Motor Drive
- Uninterruptible Power Supply
- Power conditioner

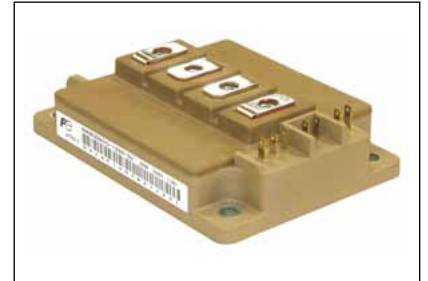

■ Maximum Ratings and Characteristics

● Absolute Maximum Ratings (at Tc=25°C unless otherwise specified)

Items		Symbols	Conditions		Maximum ratings	Units	
T1, T2	Collector-Emitter voltage	V _{GES}			1200	V	
	Gate-Emitter voltage	V _{GES}			±20	V	
	Collector current	IGBT	I _c	Continuous	T _c =80°C	100	A
			I _{cp}	1ms	T _c =80°C	200	
		FWD	-I _c			100	
			-I _{c pulse}	1ms		200	
Collector power dissipation	P _c	1 device		430	W		
T3, T4	Collector-Emitter voltage	V _{GES}			600	V	
	Repetitive peak reverse voltage	V _{RRM}			600	V	
	Gate-Emitter voltage	V _{GES}			±20	V	
	Collector current	I _c	Continuous	T _c =80°C	100	A	
		I _{cp}	1ms	T _c =80°C	200		
Collector power dissipation	P _c	1 device		400	W		
Junction temperature		T _j			150	°C	
Case temperature		T _c			125		
Storage temperature		T _{stg}			-40 ~ +125		
Isolation voltage	between terminal and copper base (*1) between thermistor and others (*2)	V _{iso}	AC : 1min.		2500	VAC	
	Mounting (*3)	-	M5		3.5	N m	

Note *1: All terminals should be connected together during the test.

Note *2: Two thermistor terminals should be connected together, other terminals should be connected together and shorted to base plate during the test.

Note *3: Recommendable value : 2.5-3.5 Nm (M5)

● Electrical characteristics (at Tj= 25°C unless otherwise specified)

Items	Symbols	Conditions	Characteristics			Units		
			min.	typ.	max.			
T1, T2	Zero gate voltage collector current	I_{CES}	$V_{GE} = 0V, V_{CE} = 1200V$	-	-	1.0	mA	
	Gate-Emitter leakage current	I_{GES}	$V_{CE} = 0V, V_{GE} = \pm 20V$	-	-	200	nA	
	Gate-Emitter threshold voltage	$V_{GE(th)}$	$V_{CE} = 20V, I_C = 100mA$	6.0	6.5	7.0	V	
	Collector-Emitter saturation voltage	$V_{CE(sat)}$ (chip)	$V_{GE} = 15V$ $I_C = 100A$	$T_j = 25^\circ C$	-	1.75	2.20	V
				$T_j = 125^\circ C$	-	2.05	-	
		$V_{CE(sat)}$ (P-U, V, W / U, V, W-N terminal)	$V_{GE} = 15V$ $I_C = 100A$	$T_j = 25^\circ C$	-	2.60	3.05	
				$T_j = 125^\circ C$	-	2.90	-	
	Internal gate resistance	$R_{g(int)}$	-	-	7.5	-	Ω	
	Input capacitance	C_{ies}	$V_{CE} = 10V, V_{GE} = 0V, f = 1MHz$	-	9.1	-	nF	
	Turn-on time	t_{on}	SW mode : A $V_{CC} = 300V$ $I_C = 100A$	-	0.44	1.20	μs	
		t_r		-	0.11	0.60		
		$t_{r(f)}$		-	0.05	-		
	Turn-off time	t_{off}	$V_{GE} = \pm 15V$	-	0.44	1.00	μs	
		t_f	$R_G = 1.6\Omega$	-	0.06	0.30		
Forward on voltage	V_F (chip)	$I_F = 100A$	$T_j = 25^\circ C$	-	1.70	2.15	V	
			$T_j = 125^\circ C$	-	1.85	-		
	V_F (P-U, V, W / U, V, W-N terminal)	$I_F = 100A$	$T_j = 25^\circ C$	-	2.55	3.00		
			$T_j = 125^\circ C$	-	2.70	-		
Reverse recovery time	t_{rr}	SW mode : A $V_{CC} = 600V$ $I_F = 100A$ $V_{GE} = \pm 15V$ $R_G = 1.6\Omega$	-	-	0.35	μs		
		SW mode : B $V_{CC} = 300V$ $I_F = 100A$ $V_{GE} = \pm 15V$ $R_G = 3.3\Omega$ (T3, T4)	-	-	0.35			
T3, T4	Zero gate voltage collector current	I_{CES}	$V_{GE} = 0V, V_{CE} = 600V$	-	-	1.0	mA	
	Gate-Emitter leakage current	I_{GES}	$V_{CE} = 0V, V_{GE} = \pm 20V$	-	-	200	nA	
	Gate-Emitter threshold voltage	$V_{GE(th)}$	$V_{CE} = 20V, I_C = 100mA$	5.5	6.5	7.5	V	
	Collector-Emitter saturation voltage	$V_{CE(sat)}$ (chip)	$V_{GE} = 15V$ $I_C = 100A$	$T_j = 25^\circ C$	-	2.45	2.80	V
				$T_j = 125^\circ C$	-	2.60	-	
		$V_{CE(sat)}$ (M-U, V, W terminal)	$V_{GE} = 15V$ $I_C = 100A$	$T_j = 25^\circ C$	-	3.30	3.65	
				$T_j = 125^\circ C$	-	3.45	-	
	Internal gate resistance	$R_{g(int)}$	-	-	8.8	-	Ω	
	Input capacitance	C_{ies}	$V_{CE} = 10V, V_{GE} = 0V, f = 1MHz$	-	6.5	-	nF	
	Turn-on time	t_{on}	SW mode : B $V_{CC} = 300V$ $I_C = 100A$	-	0.24	1.20	μs	
		t_r		-	0.10	0.60		
		$t_{r(f)}$		-	0.04	-		
	Turn-off time	t_{off}	$V_{GE} = \pm 15V$	-	0.20	1.00	μs	
		t_f	$R_G = 3.3\Omega$	-	0.03	0.30		
Reverse recovery time	t_{rr}	SW mode : A $V_{CC} = 300V$ $I_C = 100A$ $V_{GE} = \pm 15V$ $R_G = 1.6\Omega$ (T1, T2)	-	-	0.35	μs		
Thermistor	Resistance	R	$T = 25^\circ C$	-	5000	-	Ω	
			$T = 100^\circ C$	465	495	520		
	B value	B	$T = 25/50^\circ C$	3305	3375	3450	K	

● Thermal resistance characteristics

Items	Symbols	Conditions	Characteristics			Units	
			min.	typ.	max.		
Thermal resistance (1device)	$R_{th(j-c)}$	T1, T2 IGBT	-	-	0.29	$^\circ C/W$	
		T1, T2 FWD	-	-	0.44		
		T3, T4 RB-IGBT	-	-	0.31		
Contact thermal resistance (1device) (*4)	$R_{th(c-f)}$	T1, T2 T3, T4	with Thermal Compound		-	0.05	-

Note *4: This is the value which is defined mounting on the additional cooling fin with thermal compound (thermal conductivity = 1W/m · k).

■ Definitions of switching time

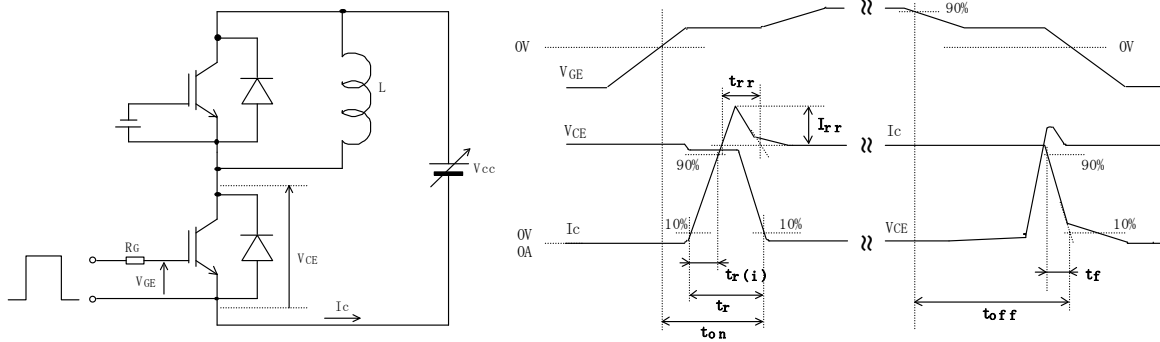

Definitions of switching mode

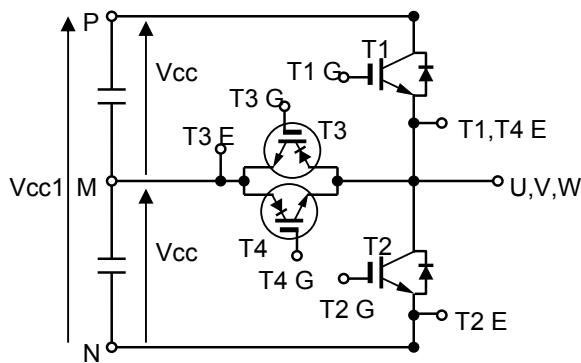

SW mode	Load L	State of switching device			
		T1	T2	T3	T4
A	M-U	SW	OFF	OFF	ON
	M-U	OFF	SW	ON	OFF
B	P-U	OFF	OFF	SW	ON
	U-N	OFF	OFF	ON	SW

SW: Connect to drive circuit and input gate signal.
 ON: Bias voltate of gate +15V.
 OFF: Reverse bias voltage of gate -15V.
 $V_{cc}=V_{cc1}/2$

■ Characteristics (Representative)

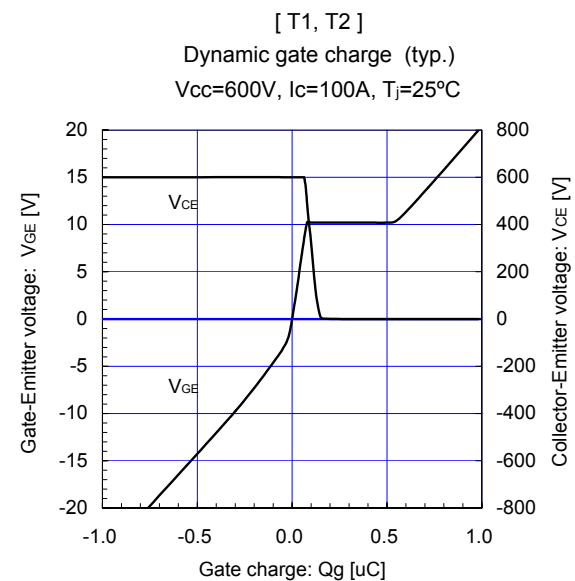
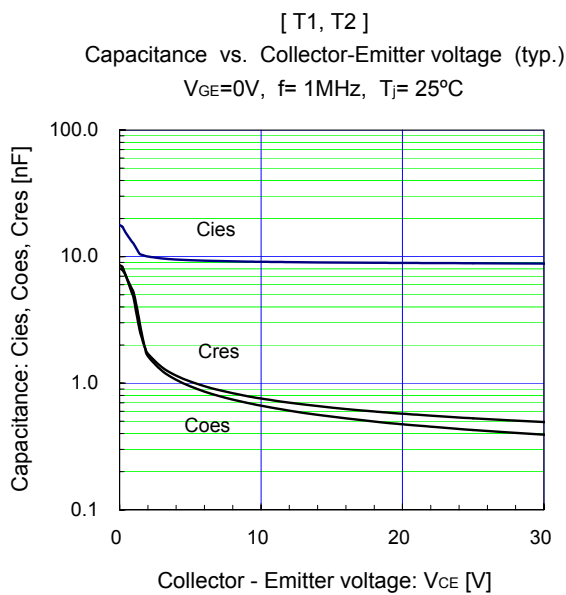
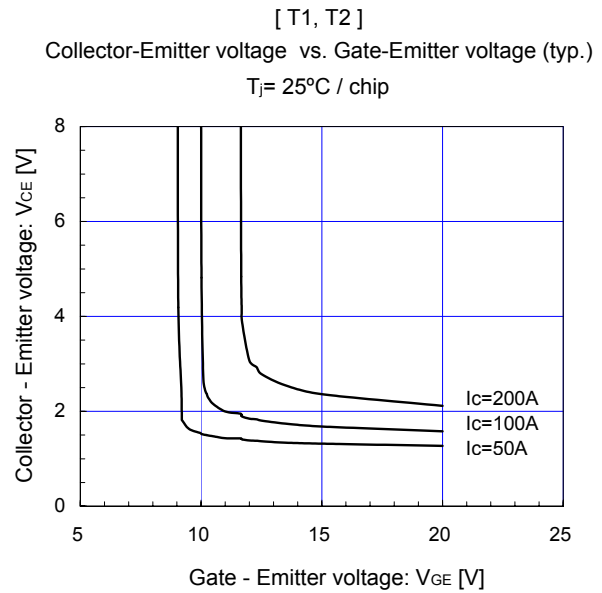
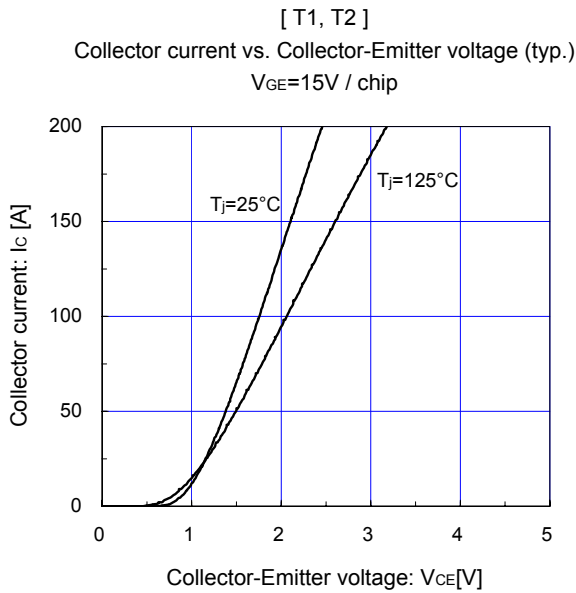
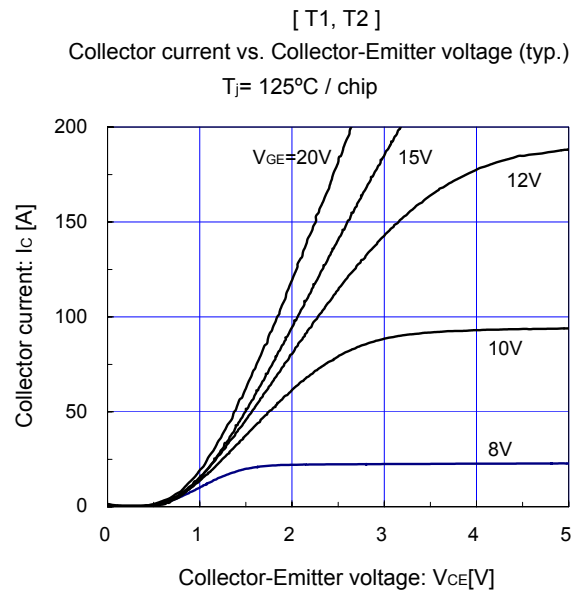
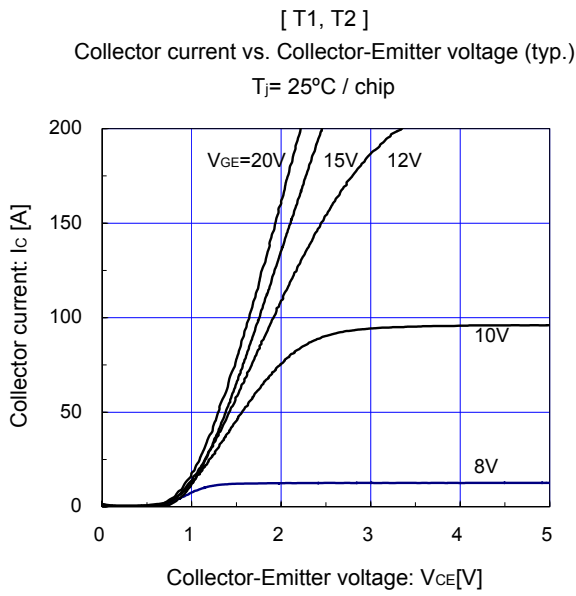

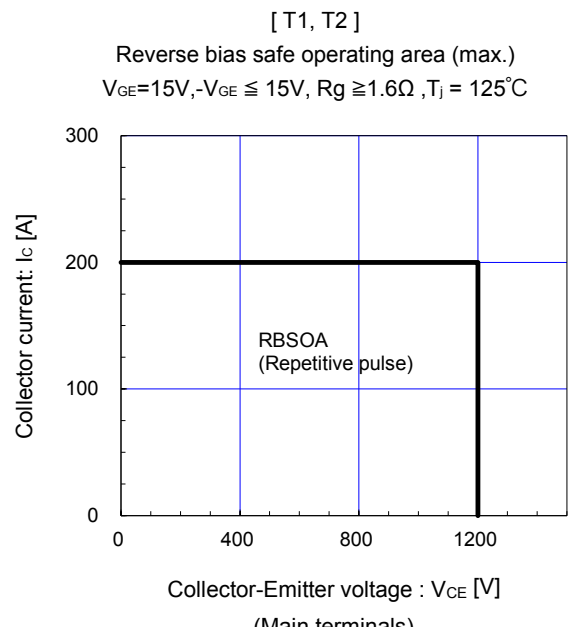
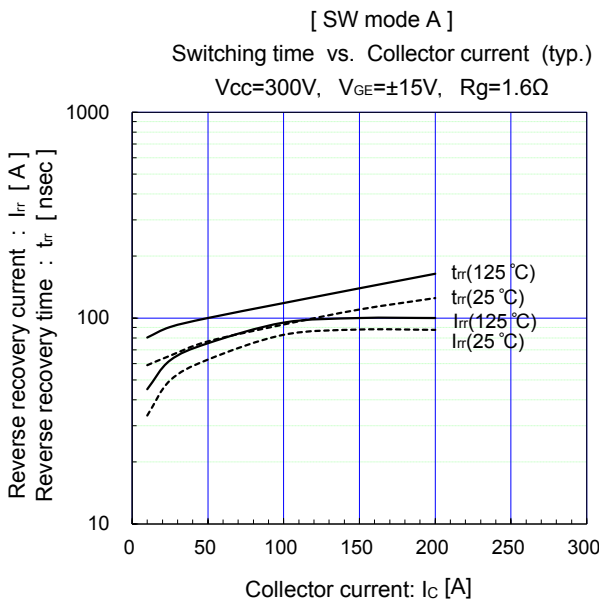
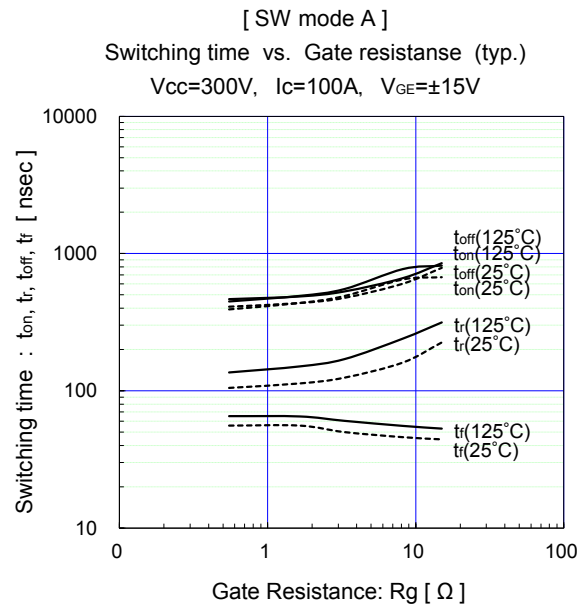
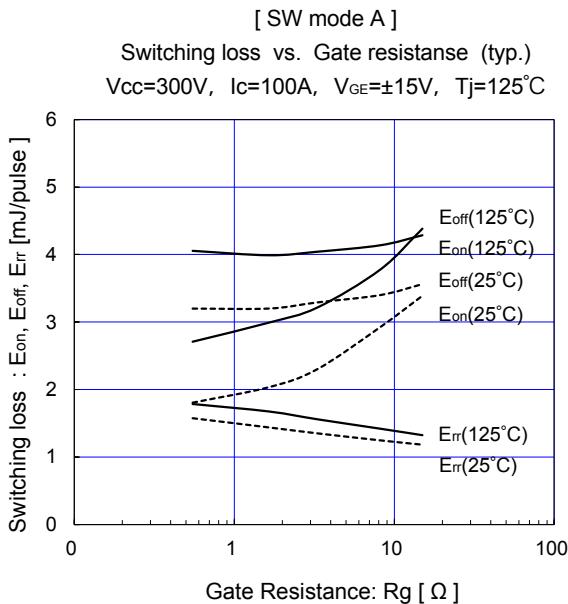
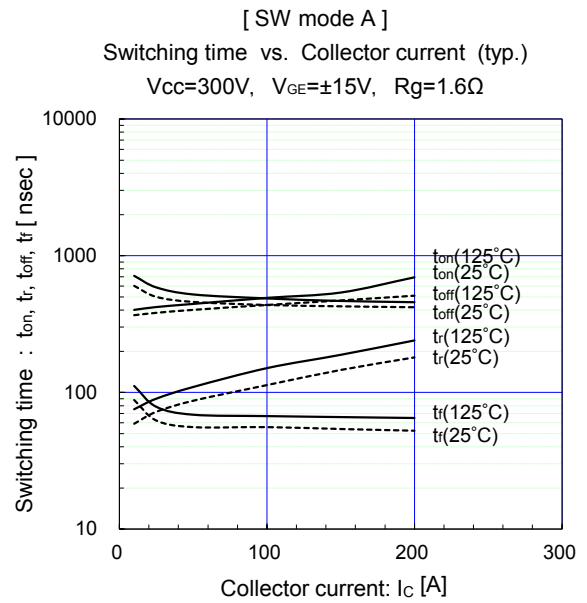
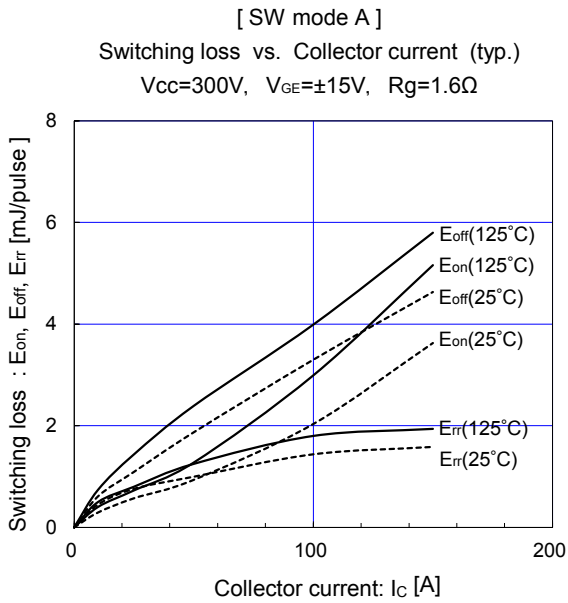

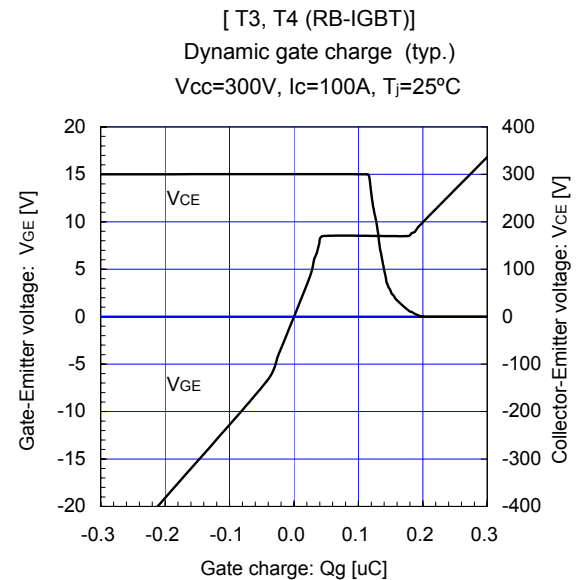
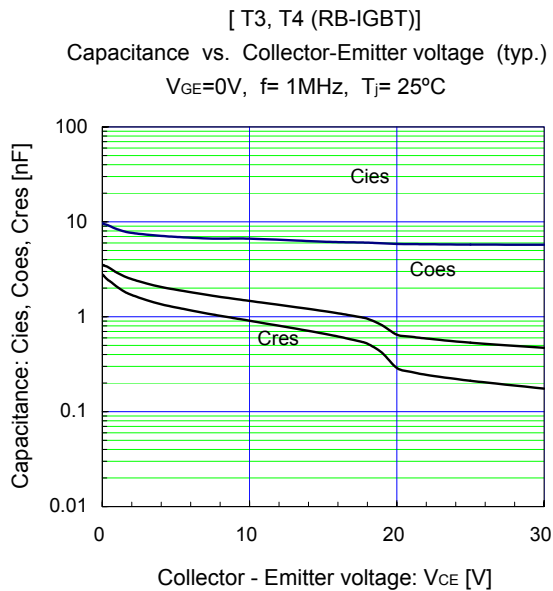
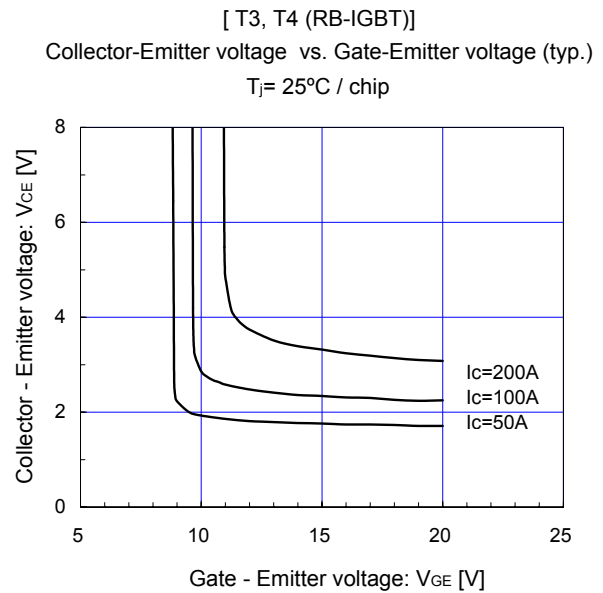
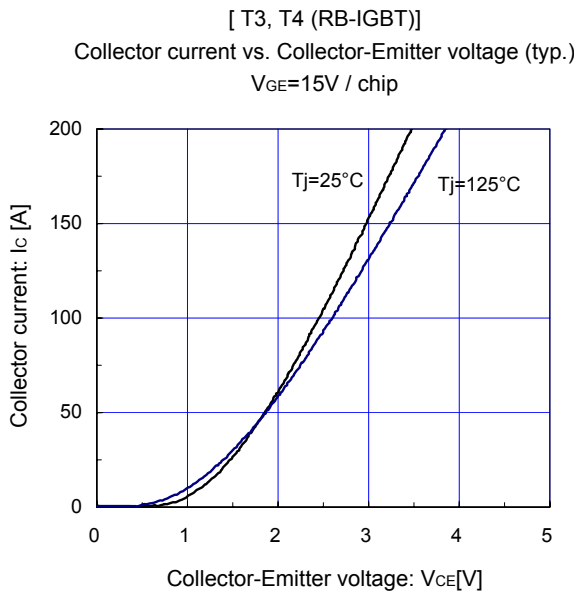
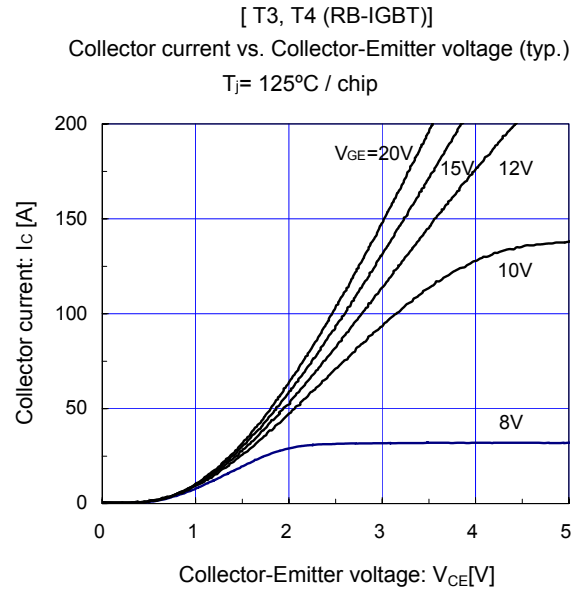
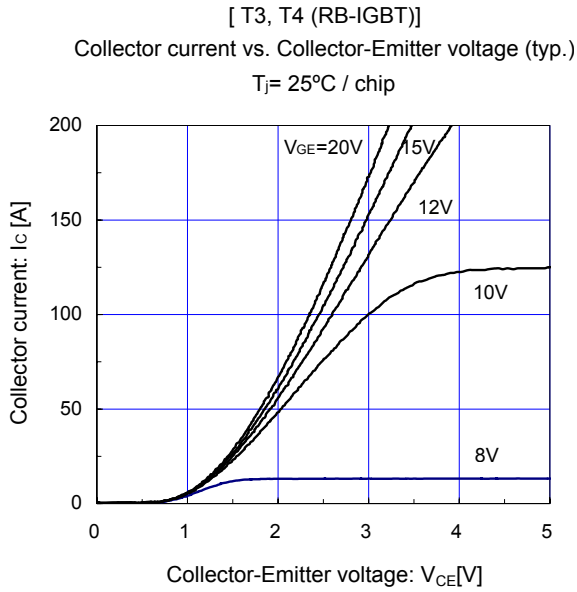

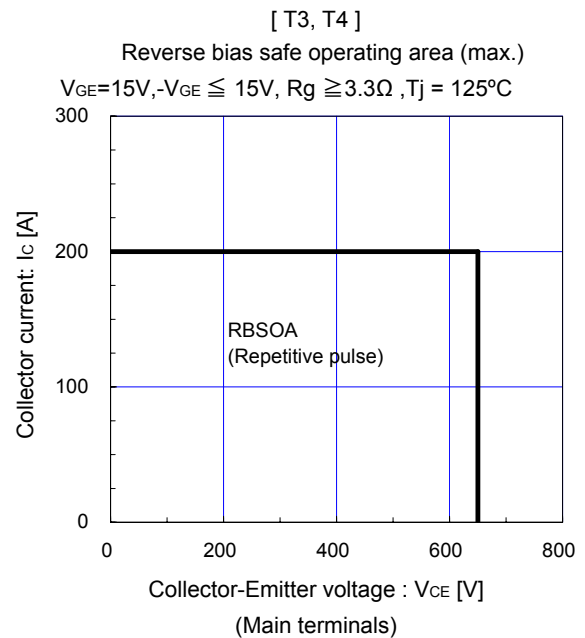
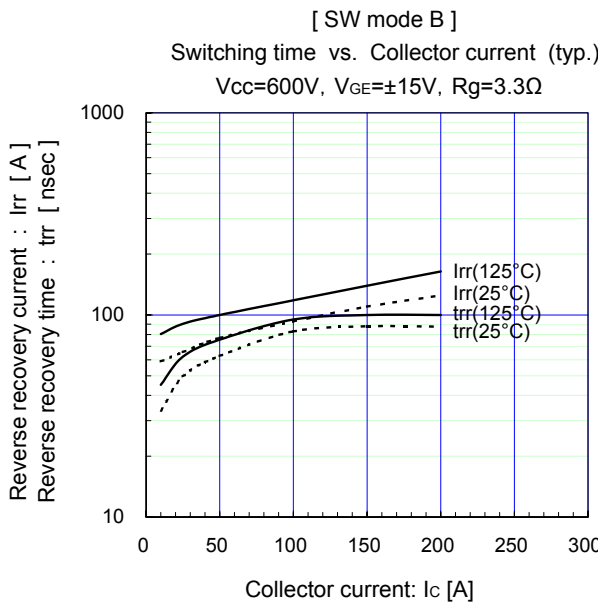
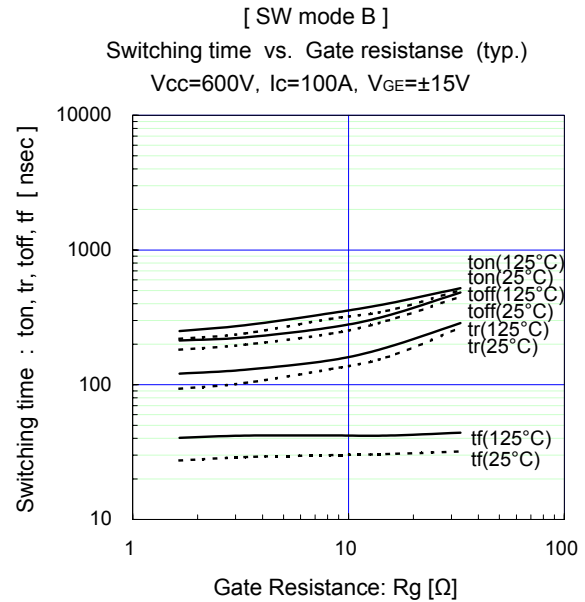
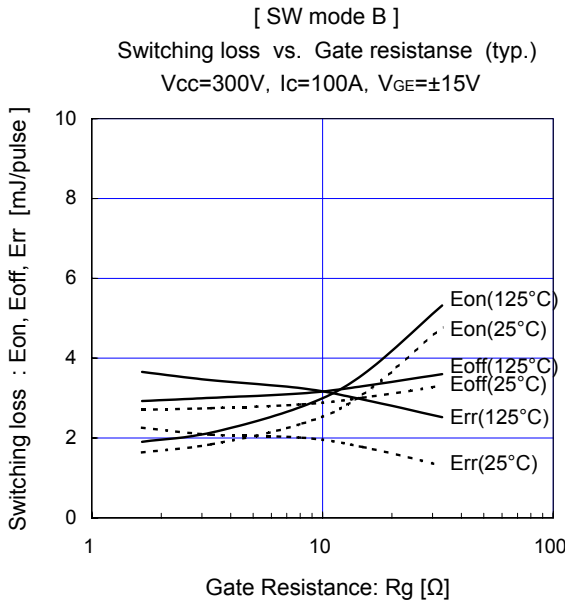
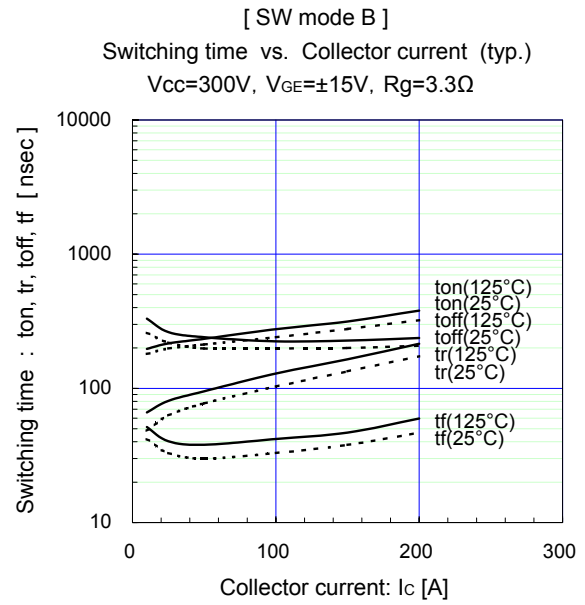
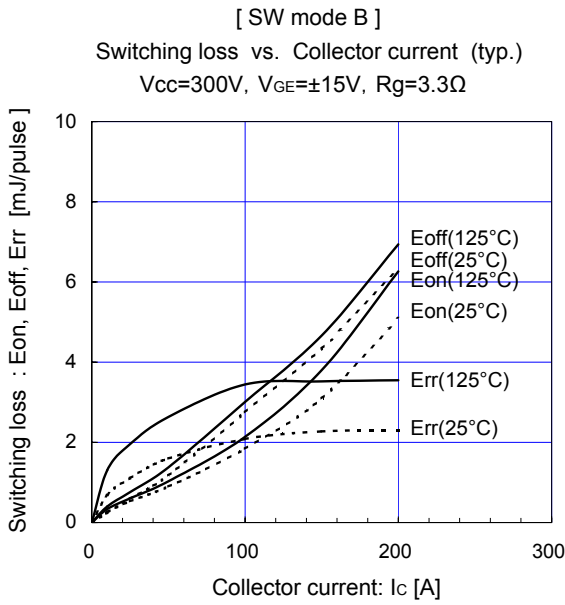

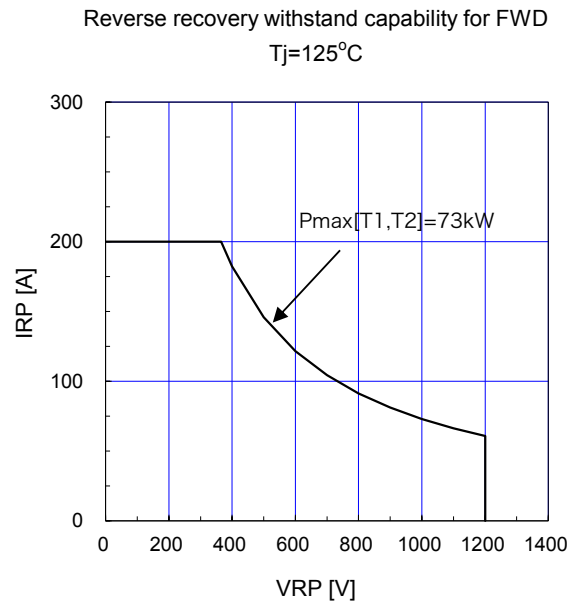
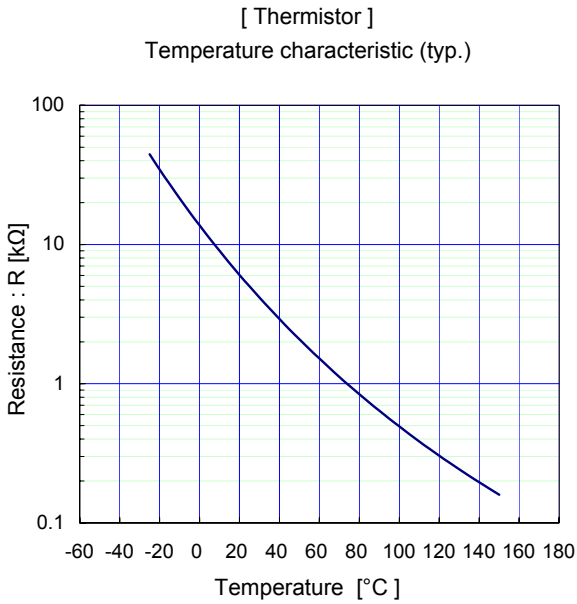
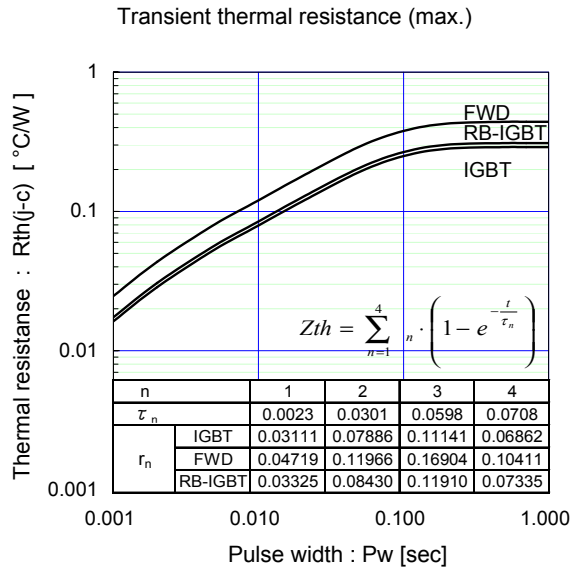
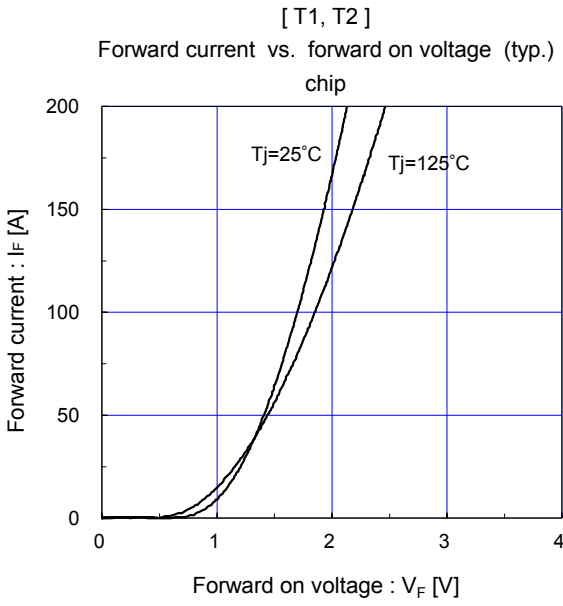

Outline Drawings, mm

□ shows theoretical dimension.
 () shows reference dimension.

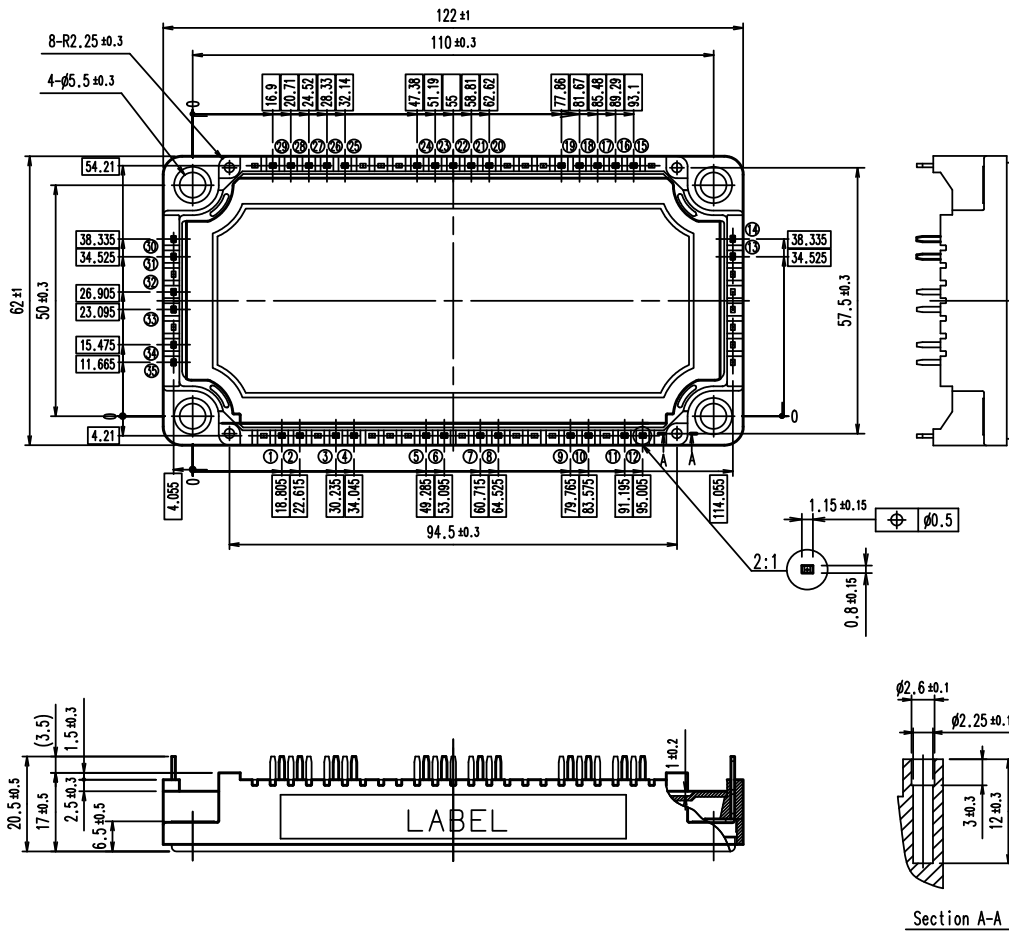

Weight: 302g (typ.)

Equivalent Circuit Schematic

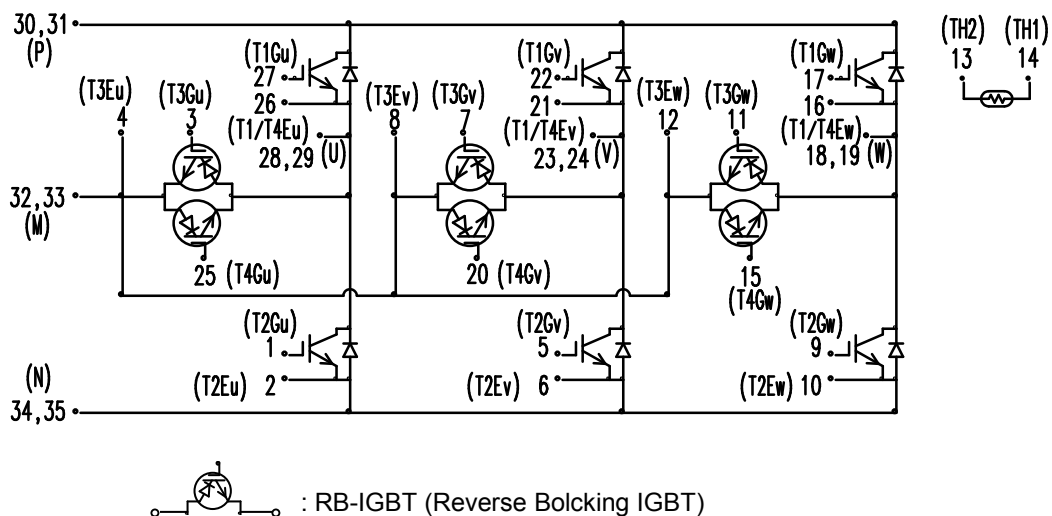

WARNING

1. This Catalog contains the product specifications, characteristics, data, materials, and structures as of June 2015.
The contents are subject to change without notice for specification changes or other reasons. When using a product listed in this Catalog, be sure to obtain the latest specifications.
2. All applications described in this Catalog exemplify the use of Fuji's products for your reference only. No right or license, either express or implied, under any patent, copyright, trade secret or other intellectual property right owned by Fuji Electric Co., Ltd. is (or shall be deemed) granted. Fuji Electric Co., Ltd. makes no representation or warranty, whether express or implied, relating to the infringement or alleged infringement of other's intellectual property rights which may arise from the use of the applications described herein.
3. Although Fuji Electric Co., Ltd. is enhancing product quality and reliability, a small percentage of semiconductor products may become faulty. When using Fuji Electric semiconductor products in your equipment, you are requested to take adequate safety measures to prevent the equipment from causing a physical injury, fire, or other problem if any of the products become faulty. It is recommended to make your design failsafe, flame retardant, and free of malfunction.
4. The products introduced in this Catalog are intended for use in the following electronic and electrical equipment which has normal reliability requirements.
 - Computers
 - OA equipment
 - Communications equipment (terminal devices)
 - Measurement equipment
 - Machine tools
 - Audiovisual equipment
 - Electrical home appliances
 - Personal equipment
 - Industrial robots etc.
5. If you need to use a product in this Catalog for equipment requiring higher reliability than normal, such as for the equipment listed below, it is imperative to contact Fuji Electric Co., Ltd. to obtain prior approval. When using these products for such equipment, take adequate measures such as a backup system to prevent the equipment from malfunctioning even if a Fuji's product incorporated in the equipment becomes faulty.
 - Transportation equipment (mounted on cars and ships)
 - Trunk communications equipment
 - Traffic-signal control equipment
 - Gas leakage detectors with an auto-shut-off feature
 - Emergency equipment for responding to disasters and anti-burglary devices
 - Safety devices
 - Medical equipment
6. Do not use products in this Catalog for the equipment requiring strict reliability such as the following and equivalents to strategic equipment (without limitation).
 - Space equipment
 - Aeronautic equipment
 - Nuclear control equipment
 - Submarine repeater equipment
7. Copyright ©1996-2015 by Fuji Electric Co., Ltd. All rights reserved.
No part of this Catalog may be reproduced in any form or by any means without the express permission of Fuji Electric Co., Ltd.
8. If you have any question about any portion in this Catalog, ask Fuji Electric Co., Ltd. or its sales agents before using the product.
Neither Fuji Electric Co., Ltd. nor its agents shall be liable for any injury caused by any use of the products not in accordance with instructions set forth herein.